

*Touching your  
senses and  
lighting your  
passions, our  
fireplaces are the  
heart and soul  
of your home*



# Our line of clean-faced wood burning fireplaces will make their mark in stone.



*I love the sound and scent of a real wood fire burning.*



*The crackling fire in my Exclaim strikes just the right chord for the evening.*



We've created an exclusive offering of fireplaces designed to be finished right up to the doors with your favorite stone, marble, granite or tile. The result is a classic masonry look without all the fuss. And with several styles and sizes to choose from, you'll never need to worry about being stuck between a rock and a hard place.

The new Exclaim series, shown at right, offers viewing areas of magnificent proportions. With a choice of a traditional or herringbone brick interior and an elegant array of door options, our clean-faced fireplaces can turn any living area from casual to spectacular.

#### **Exclaim-36**

Just the right size for most applications, the Exclaim-36 makes any room stand out. The selection of glass or mesh door options allows for that extra personal touch.

#### **Exclaim-42**

A bolder statement that transforms your family room. Stack in the wood and sit back for a full fireplace experience with your Exclaim-42.

#### **Exclaim-50**

The view doesn't get any bigger or more spectacular. The Exclaim-50 offers a vision of epic proportions, something any lodge would be envious of.



**Exclaim-36** Shown with optional DM-6036S doors & herringbone refractory



**Exclaim-42** Shown with optional DM-8042S doors & herringbone refractory



**Exclaim-50** (Below) Shown with standard parting mesh and traditional refractory



# Clean and simple. The North Star makes a difference inside your home and out.



*My mementos have found their natural place*



*Nothing makes you appreciate a fire like splitting your own wood.*



*I don't need to leave home to get that feeling of being in the North Woods.*

Sometimes the answer is so obvious, there really is no decision to make. In the case of the North Star, you needn't make a choice. Approved to EPA-Phase II standards, the North Star meets the strictest environmental standards in the country with low particulate matter emissions of only 3.25 grams per hour. This allows you to enjoy a beautiful, roaring fire and be a friend to the environment at the same time. Just as importantly, we've created a ruggedly traditional look that is matched only by its heating capacity.

Capable of producing up to 51,000 Btu/Hour and boasting a 77.8% efficiency rating, the North Star will warm you up on the coldest of nights. And with two standard fans and up to two optional Heat-Zone kits, it can heat up other areas of the home as well.





Model NorthStar-NT  
with brushed nickel-trimmed doors

NorthStar-BK (Below) Shown with black cabinet style doors



# Parties for hosting, marshmallows for toasting; that's a song you'll enjoy singing for years to come in front of a crackling fire

Sometimes a little warmth from the fire is all that's needed. Other times, Old Man Winter is brewing up an icy storm. With our line of heat-circulating fireplaces, the heat truly is on. The Energy Master Series boast efficient high heat outputs, all encapsulated within an elegant fireplace. The EM-485T takes it to a new level by offering a bountiful view of the fire and, like its smaller brother the EM-415, pumps out plenty of heat to make it cozy on the coldest of nights.



*The fireplace creates the focal point to bring together the style of the room.*



*It's the perfect spot to share some wine or set up fondue.*

## **EM-415**

Combining contemporary looks with enhanced heat output, the EM-415 offers a stylish addition for any home.

## **EM-485T**

Featuring heat tubes, the EM-485T offers a dramatic 42" viewing area and various door styles to match your existing decor.

**EM-415** Shown with optional DM 1736 doors

**EM-485T** (Below) Shown with optional DM 1742 doors





**HST-48D** Shown with optional DM1242B polished brass bi-fold doors



**Bay-40** (above) A unique shape that sets the tone for the rest of the room, and rooms beyond.

**Pier-40** (below) Whether as a room divider or as a centerpiece to your home, the Pier-40 is spectacular from any point of view.



## A view so nice, we'll show it twice – or thrice!



*My fireplace provides a perfect textbook ending to my day.*



When you're looking for a real show-stopper for your home, you can look again. Our multi-sided woodburning fireplaces allow for enjoyment of the crackling fire from different areas of the room, or different rooms.

Whole new vistas will be opened up for you to create a warm and enticing gathering spot for your family and friends. Transform the mundane into the memorable – you'll be doubly-pleased.

# Premier Wood Line Drawings

Refer to installation manual for detailed specifications on installing these products.

## Model North Star

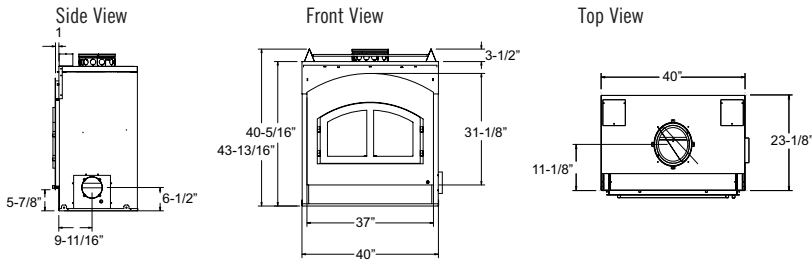

## Exclaim Models 36 - 42 - 50

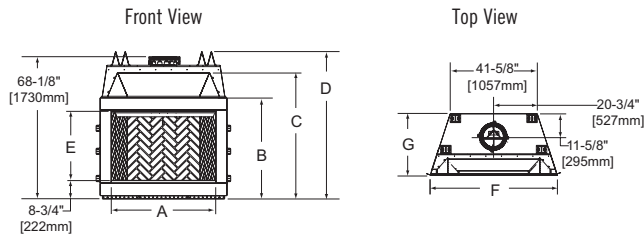

## Exclaim Specifications

MODEL	DIMENSION A	DIMENSION B	DIMENSION C	DIMENSION D	DIMENSION E	DIMENSION F	DIMENSION G
Exclaim 36	36	43-1/8	49-5/8	59 1/4	28-12	44 1/2	27 1/2
Exclaim 42	42	43-1/8	49-5/8	59 1/4	28-1/2	50 1/2	27 1/2
Exclaim 50	50	48-3/8	60-1/4	70-1/2	33	60-5/8	29-1/2

Reference dimensions only. We recommend measuring individual units at installation.

## Energy Master Model EM-415

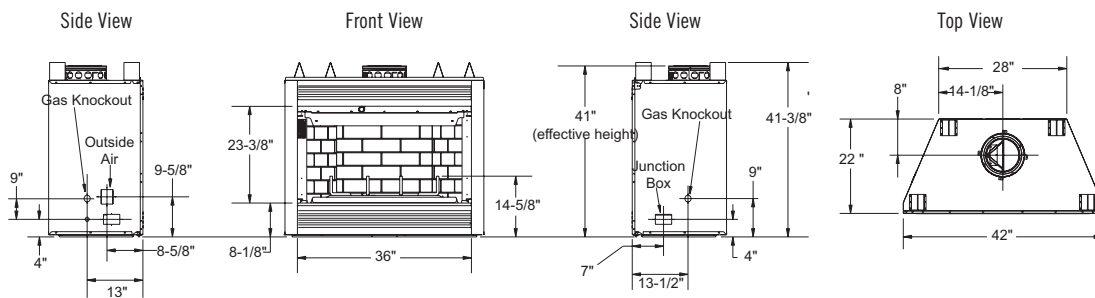

## Energy Master Model EM-485T

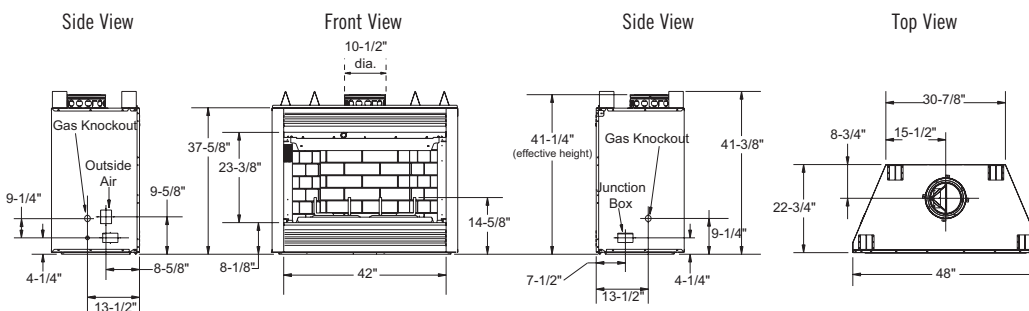

## Models HST-42D and HST-48D

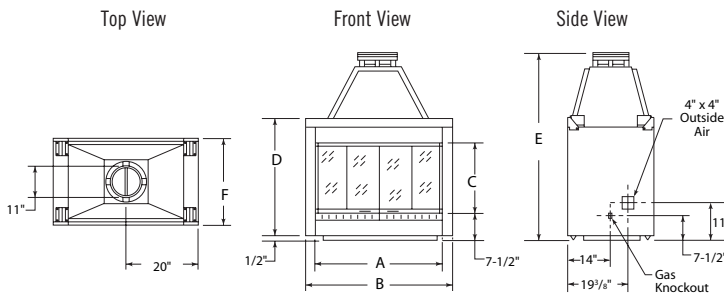

## HST Specifications

MODEL	DIMENSION A	DIMENSION B	DIMENSION C	DIMENSION D	DIMENSION E	DIMENSION F
HST-42D	36	40	20-7/8	41-1/2	47-1/4	24
HST-48D	42	47	23	38-1/2	58-7/8	28

Reference dimensions only. We recommend measuring individual units at installation.

## Models Bay-40 and Pier-40

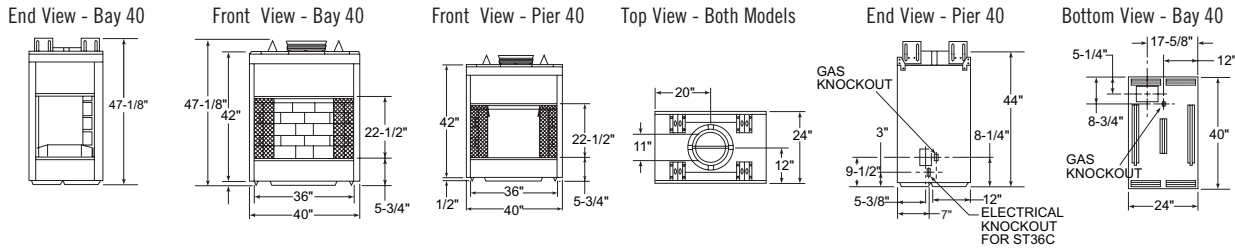

## Specifications

MODEL	FRONT HEIGHT		REAR HEIGHT		FRONT WIDTH		BACK WIDTH		DEPTH		GLASS SIZE
	Actual	Framing	Actual	Framing	Actual	Framing	Actual	Framing	Actual	Framing	
EM-415	41 3/8	41 1/2	41 3/8	41 1/2	42	43	28 1/4	43	22	23	36 x 23 1/2
EM-485T	41 3/8	41 7/8	41 3/8	41 7/8	48	49	30 7/8	49	22 3/4	23 1/4	42 x 23 1/2
North Star*	43 13/16	43 13/16	43 13/16	43 13/16	40	42	40	42	23 1/8	24	13 x 22
HST-42D	41	41 1/2	41	41 1/2	40	41	40	41	24	23	36 x 20 1/2
HST-48D	39 1/4	39 3/4	39 1/4	39 3/4	47	48	47	48	28	27	42 x 23
PIER-40	47 1/8	47 5/8	47 1/8	47 5/8	40	40	40	40	24	23	36 x 20 7/8
BAY-40	47 1/8	47 5/8	47 1/8	47 5/8	40	39	40	39	24 1/2	23 1/2	36 x 20 7/8
Exclaim-36	49 5/8	49 3/4	59 1/4	60	44 1/2	45 1/2	28 5/8	45 1/2	27 1/2	28	36 X 28 1/2
Exclaim-42	49 5/8	49 3/4	59 1/4	60	50 1/2	51 1/2	34 1/2	51 1/2	27 1/2	28	42 X 28 1/2
Exclaim-50	60 1/4	61	60 1/4	61	60 5/8	61 5/8	41 5/8	61 5/8	29 1/2	30 3/8	50 X 33

Refer to installation manual for detailed specifications on installing this product. HEAT & GLO reserves the right to update units periodically. Pictures in this brochure are not true representation of the colors of the fireplace and/or flames. These products are covered by one or more patented technologies.

\* Tested to EPA Phase II Standards, the North Star fireplace meets the strictest environmental standards for woodburning fireplaces and can be used in areas where conventional woodburning appliances are restricted or banned.

\* Btu of Cord Wood Fuel are to be used as a guideline only and may differ due to type of wood and moisture content.

**HEAT & GLO™**

20802 Kensington Boulevard, Lakeville, MN 55044  
(888) 427-3973 (952) 985-6000

Web: [heatnglo.com](http://heatnglo.com)

A brand of Hearth & Home Technologies, Inc.



HNG-1029U-0407

For complete details on  
Premier Woodburning Fireplaces, please contact us: